

VT 1xOS/Bru
Matthi

110-116

122-128

134-140

146-152

158-164

170-176

RT 1xOS/Bru
Matthi

170-176

158-164

146-152

134-140

122-128

110-116

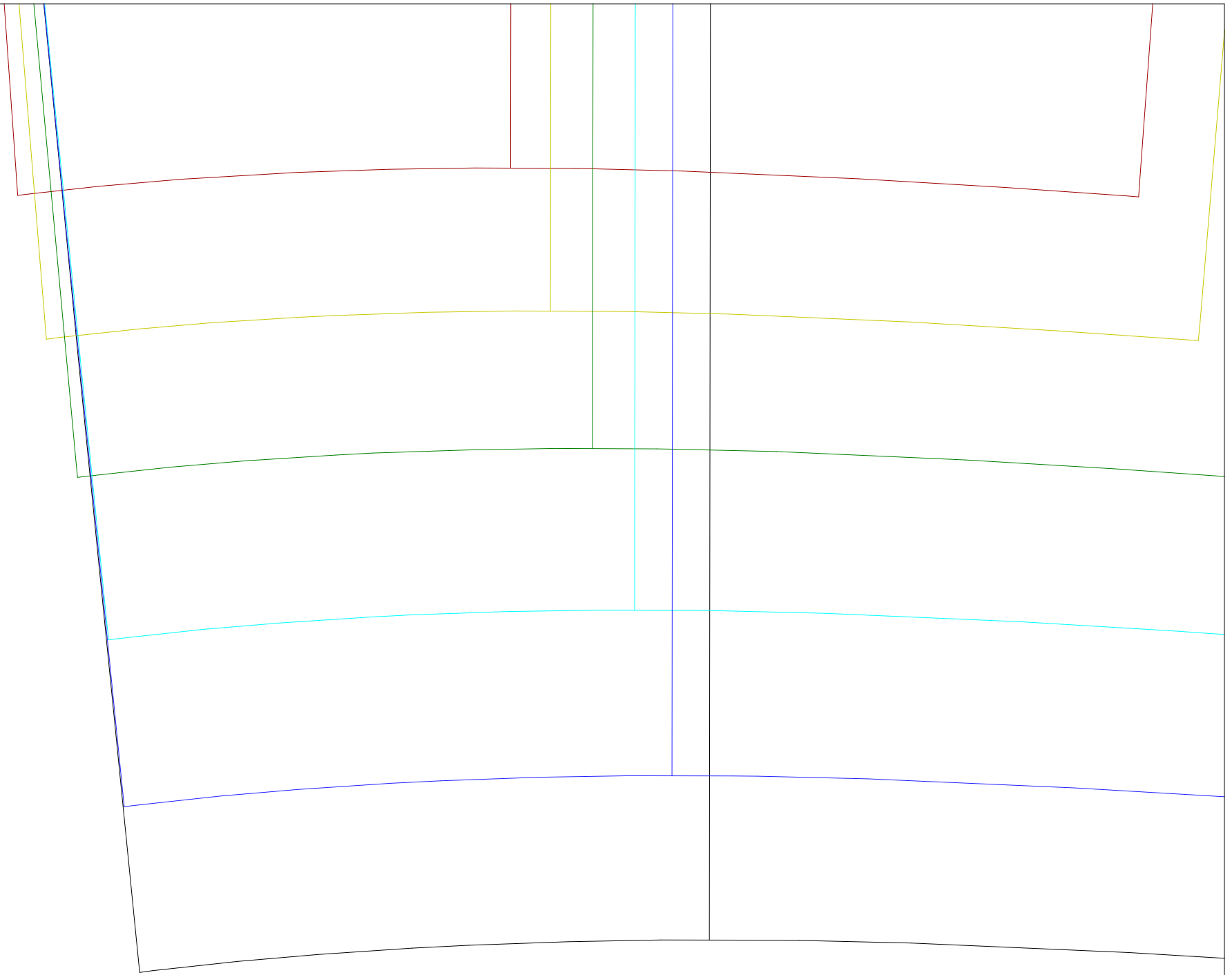

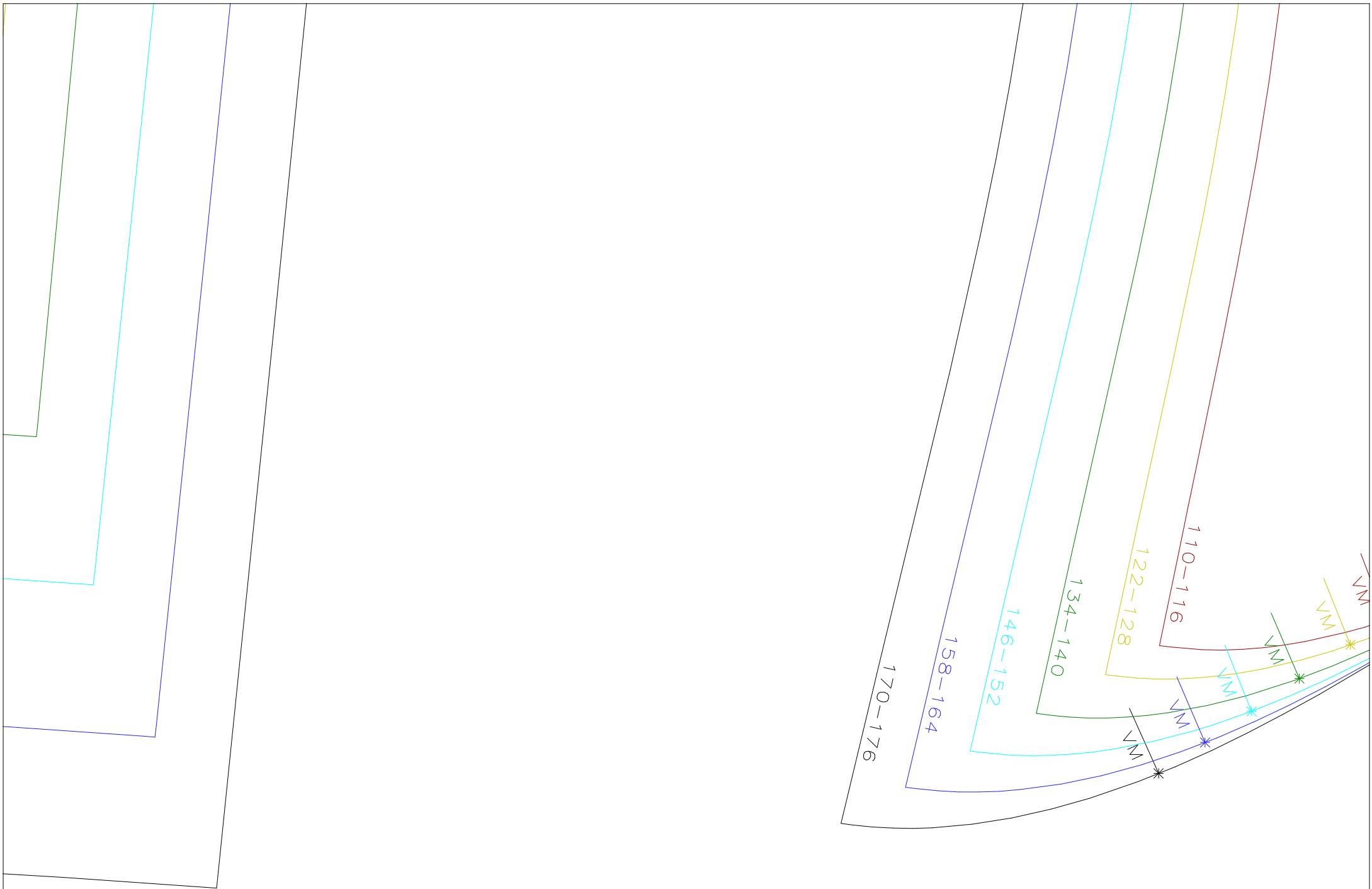

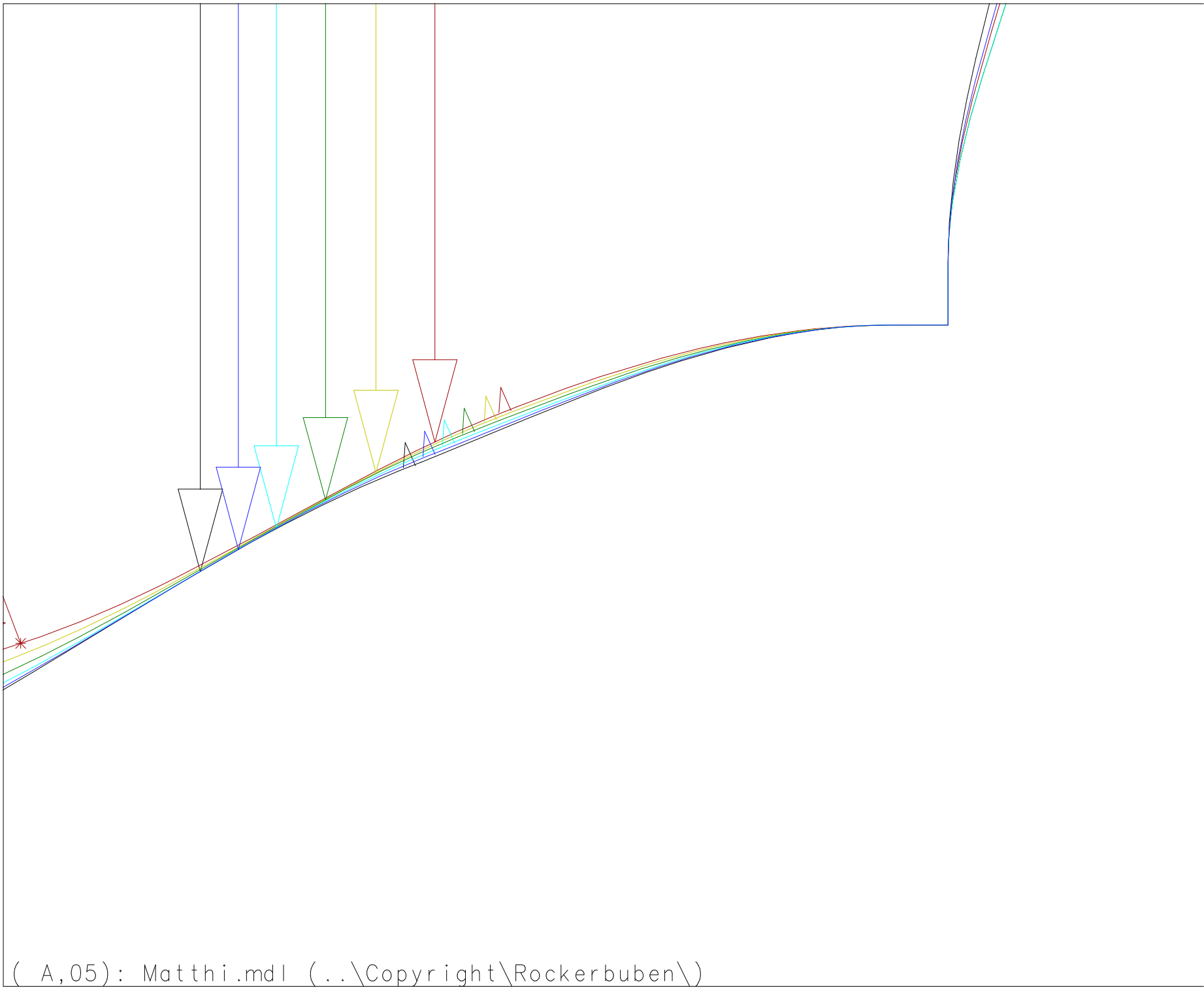

VM Bruch/ Fadenlauf

VM

Kontrolle
3x3cm

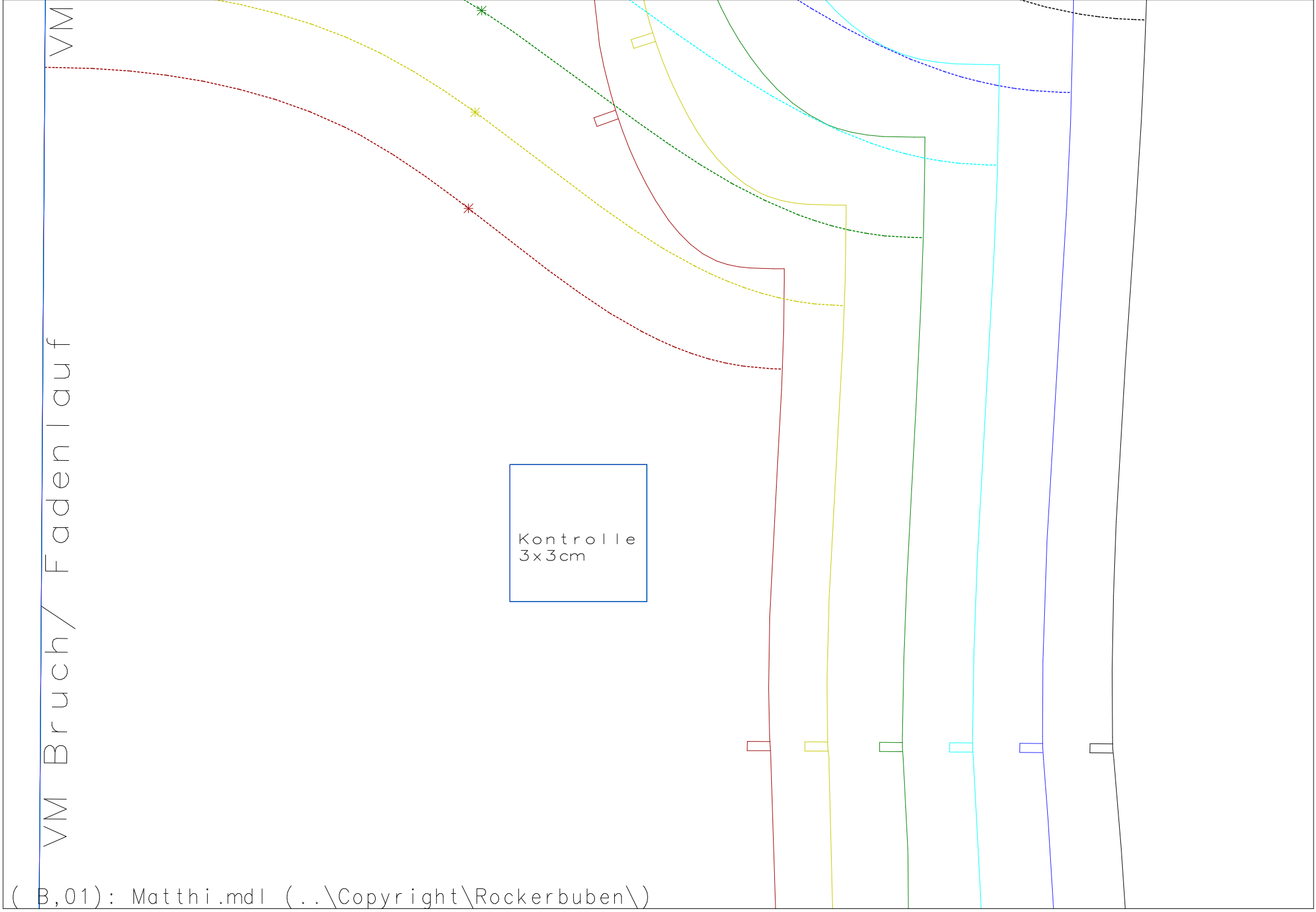

HM Bruch / Fadenlauf

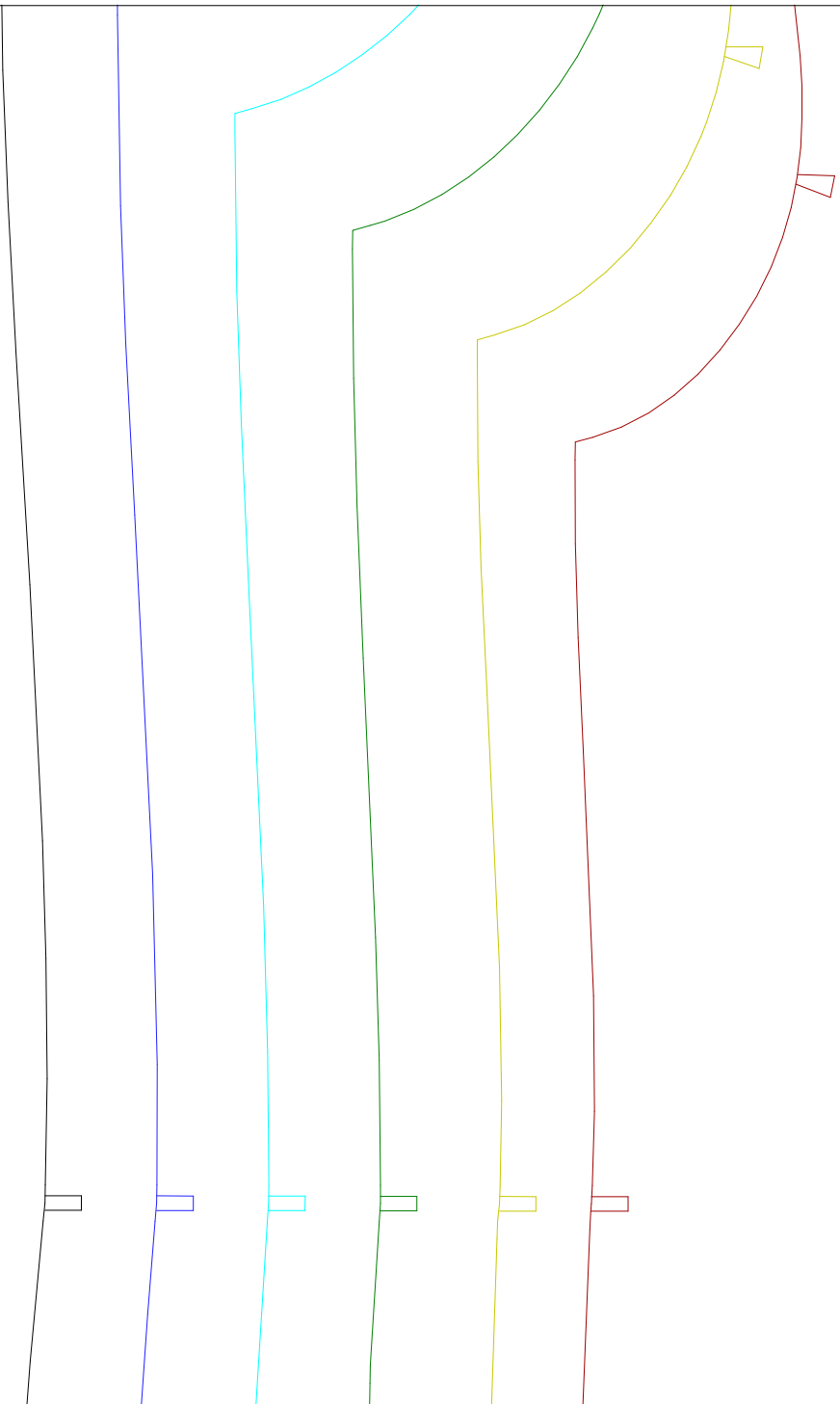

Ärme l 2x0S
Matthi

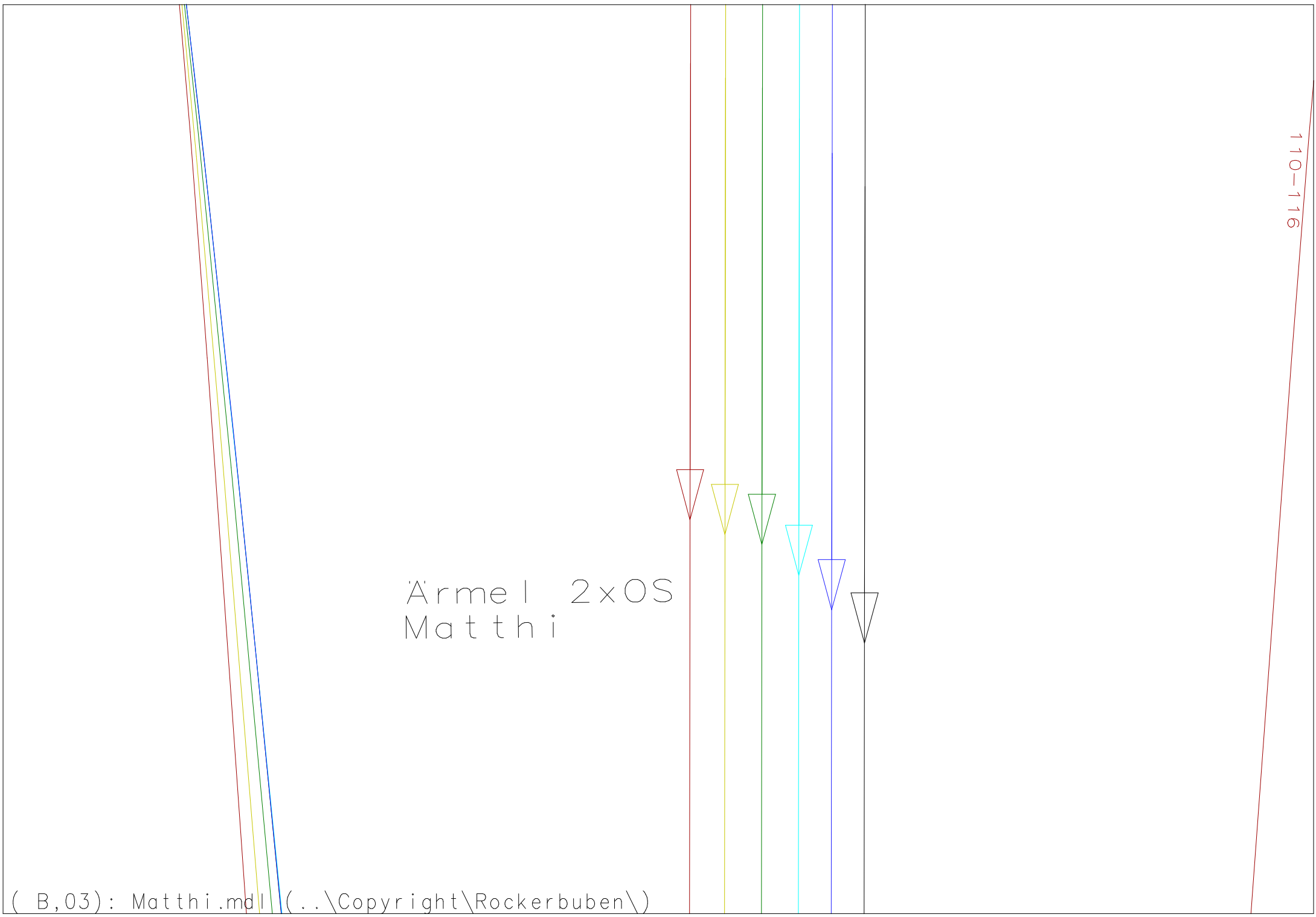

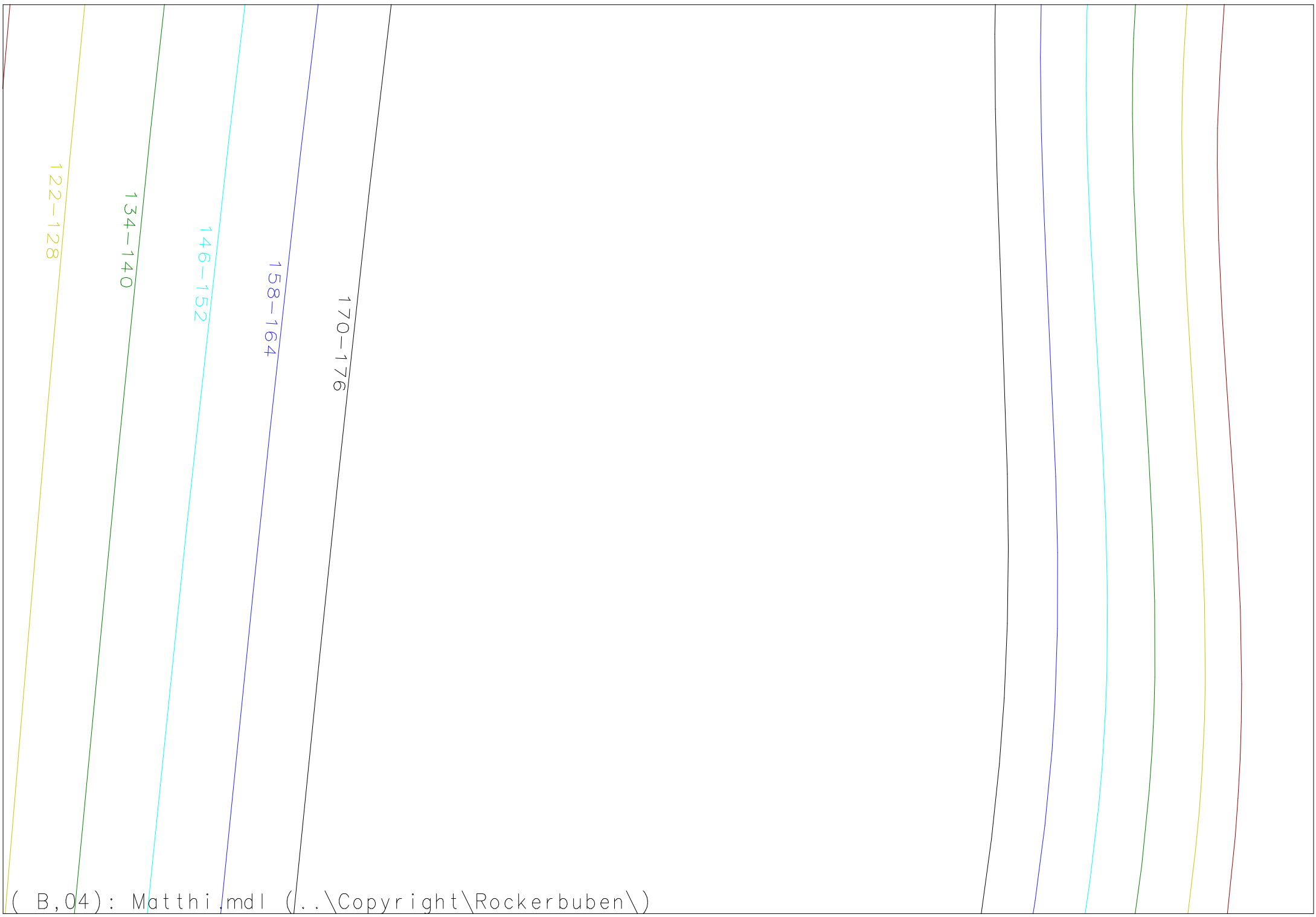

170-176

158-164

146-152

134-140

122-128

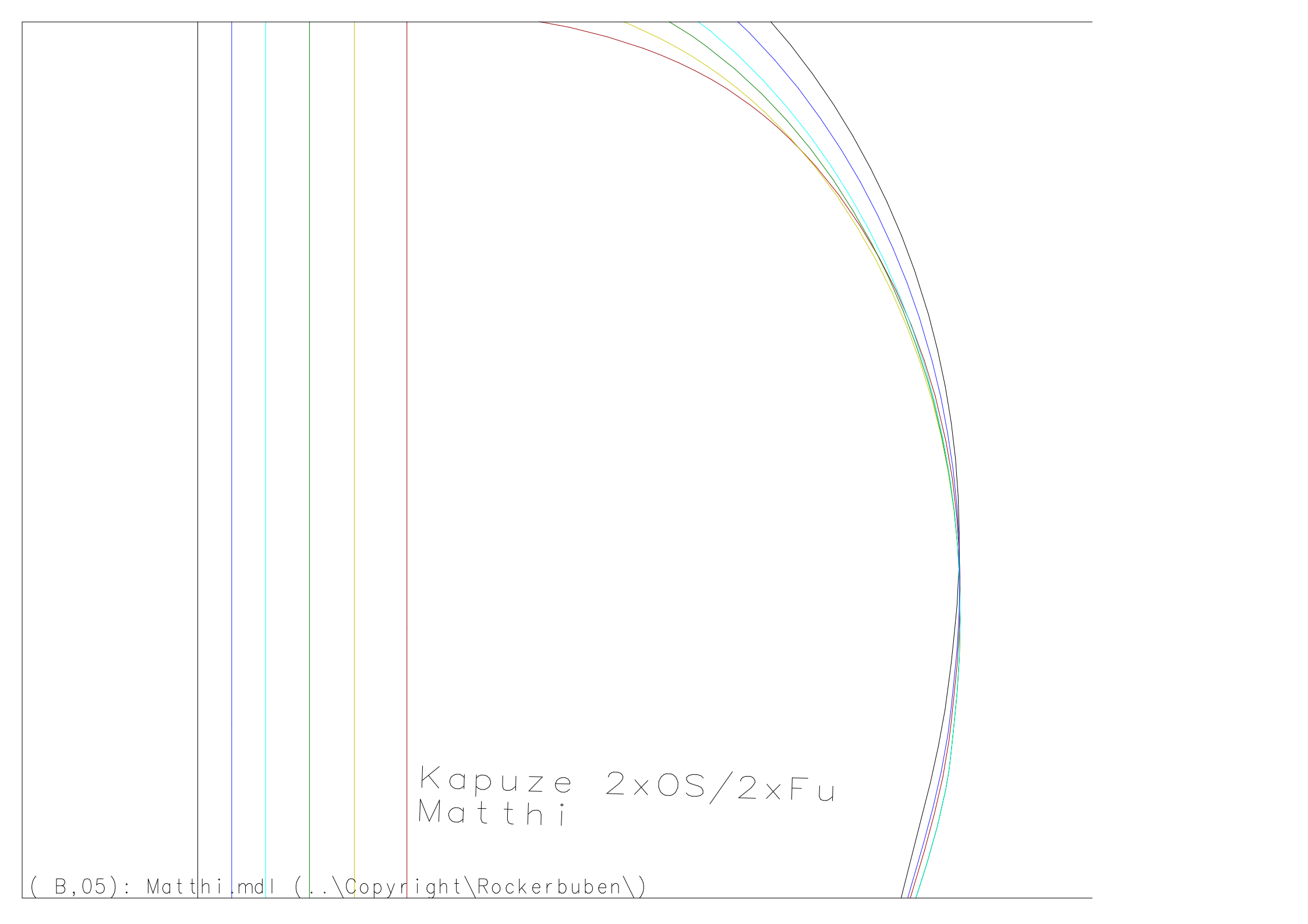

Kapuze 2xOS/2xFu
Matthi

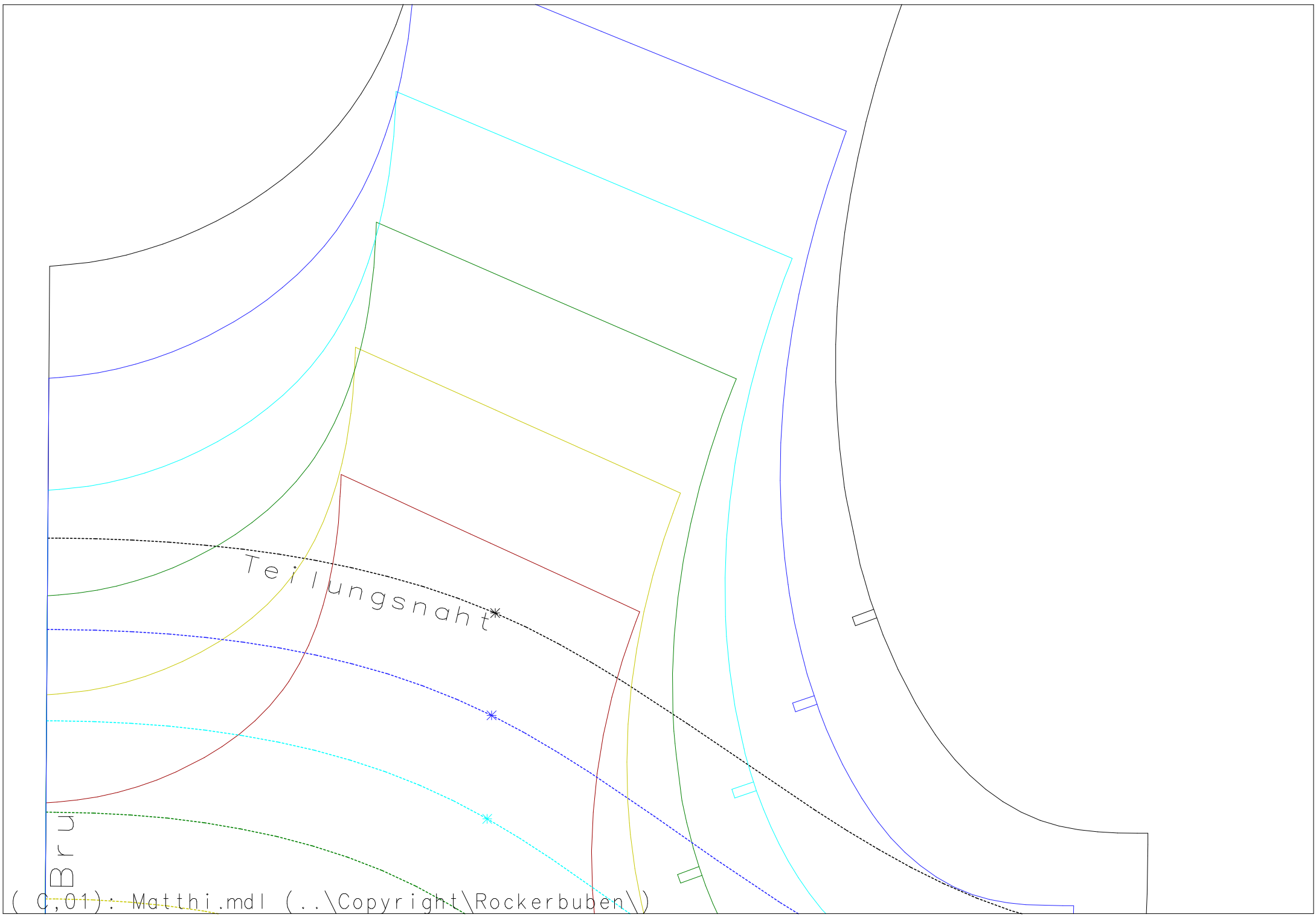

Teilungsnah*

Br u

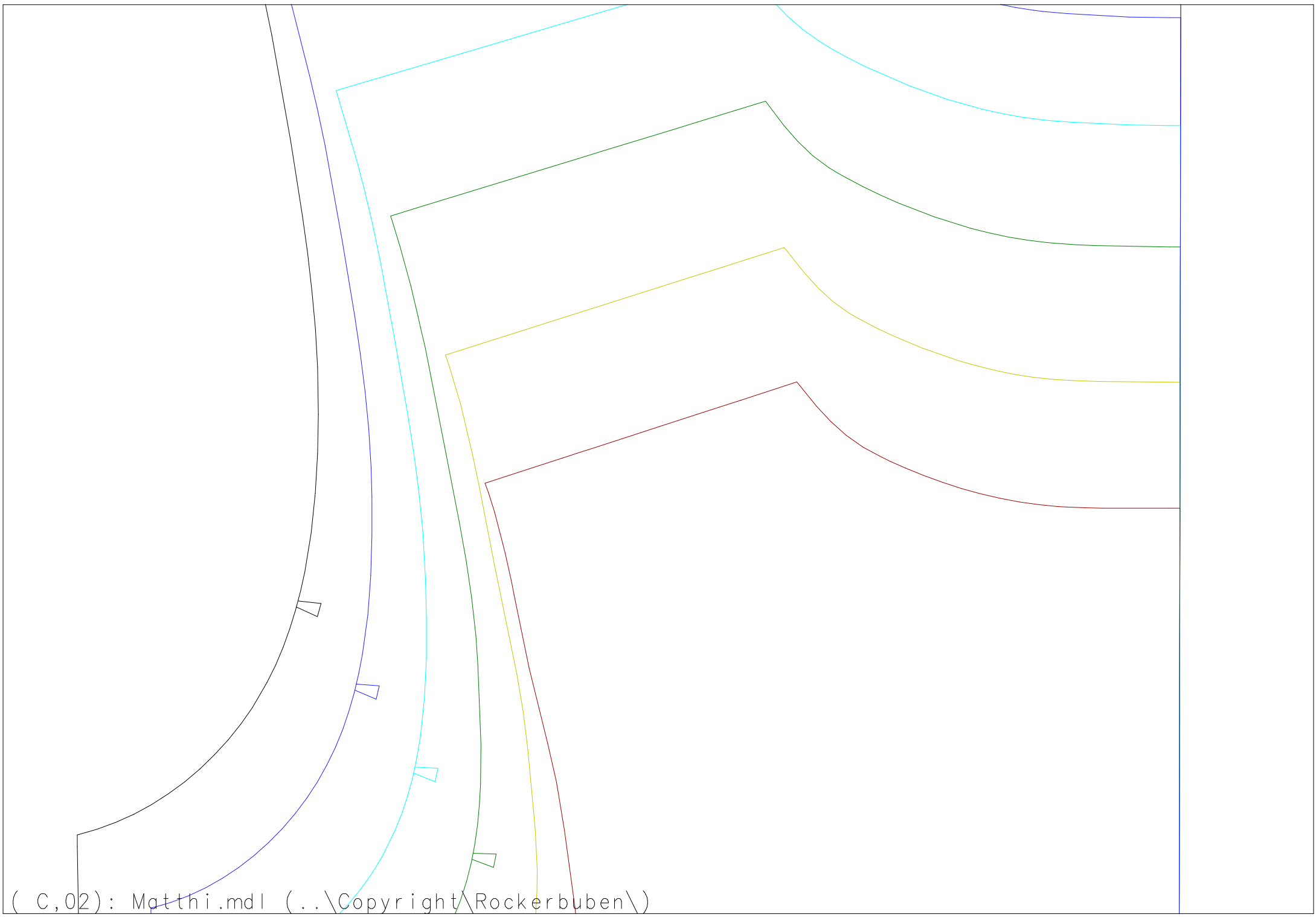

(C,02): Matthi.mdl (..\Copyright\Rockerbuben\)

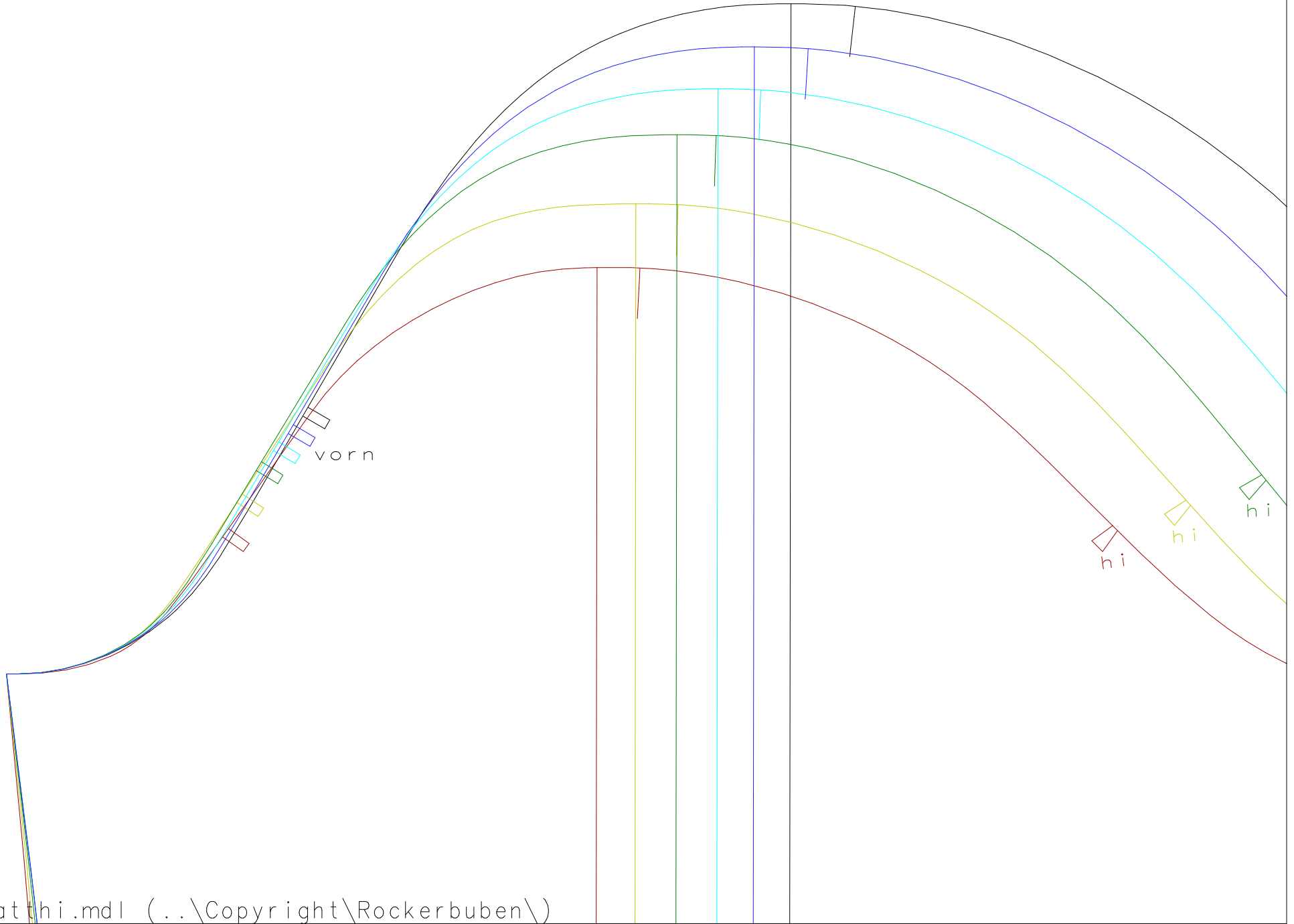

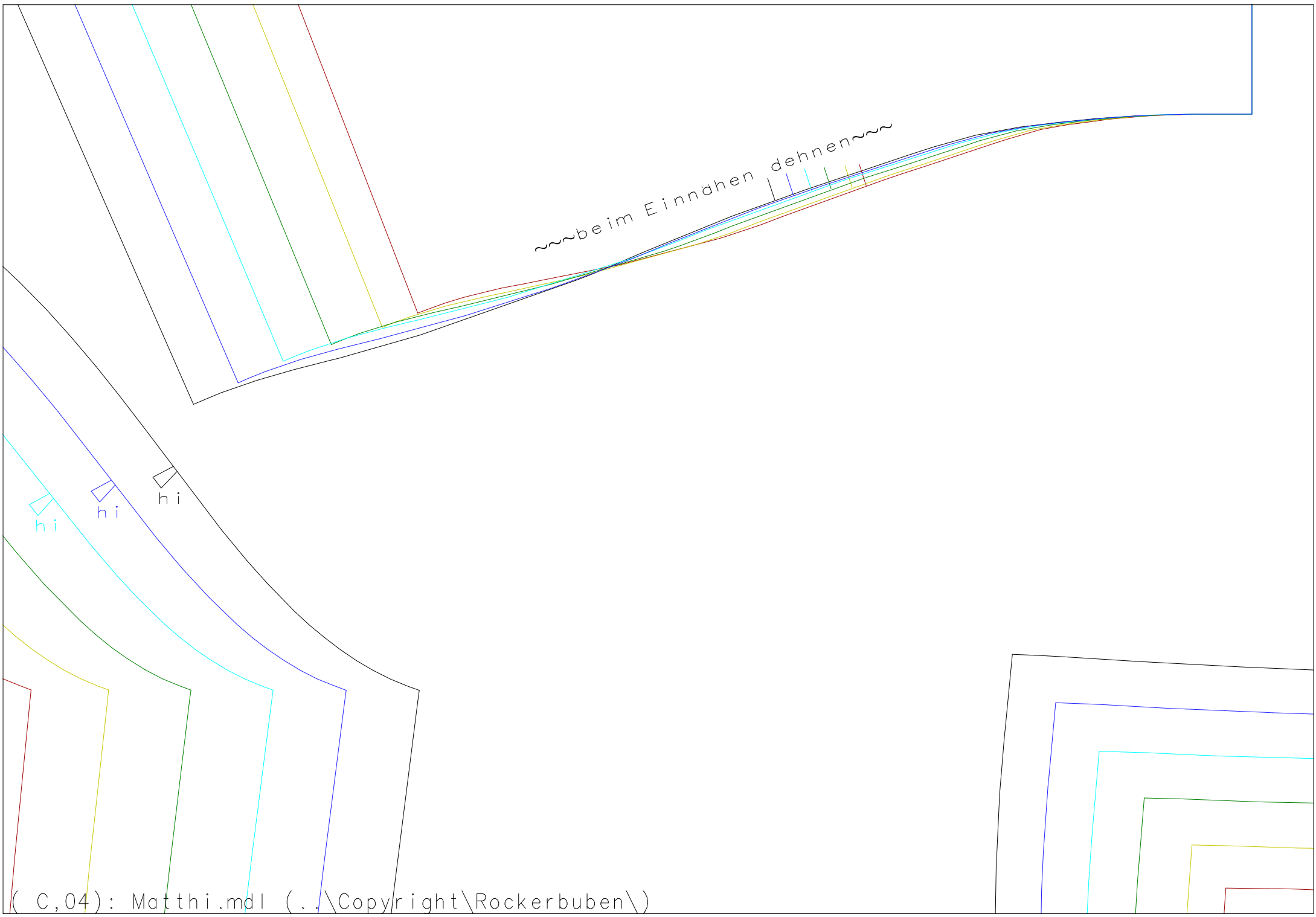

beim Einnähen dehnen

hi hi hi

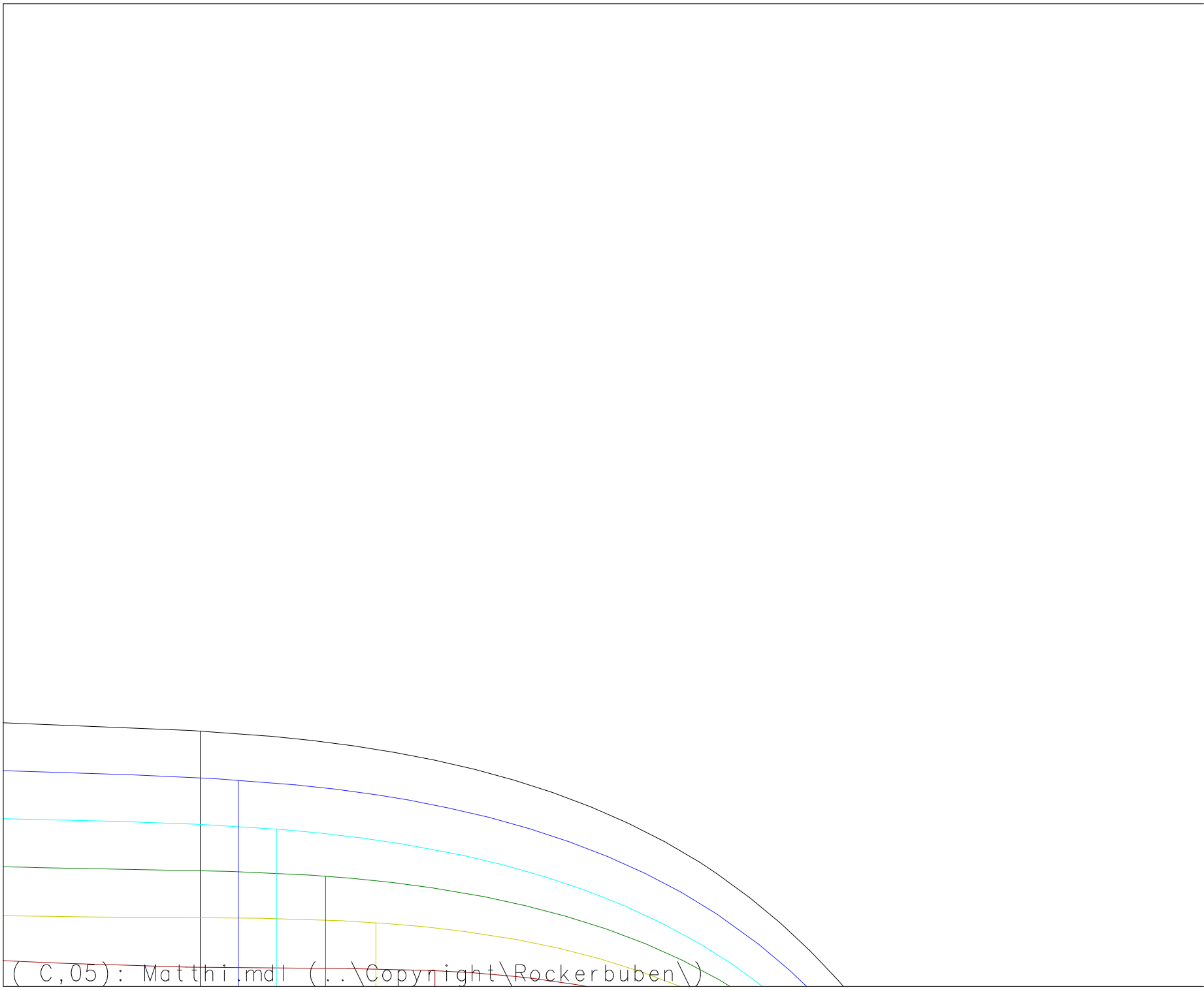

(C,05): Matthi.mdl (..\Copyright\Rockerbuben\)

~~~beim Einnähen dehnen~~~

Bündchen Arm 2x0S  
Matthi

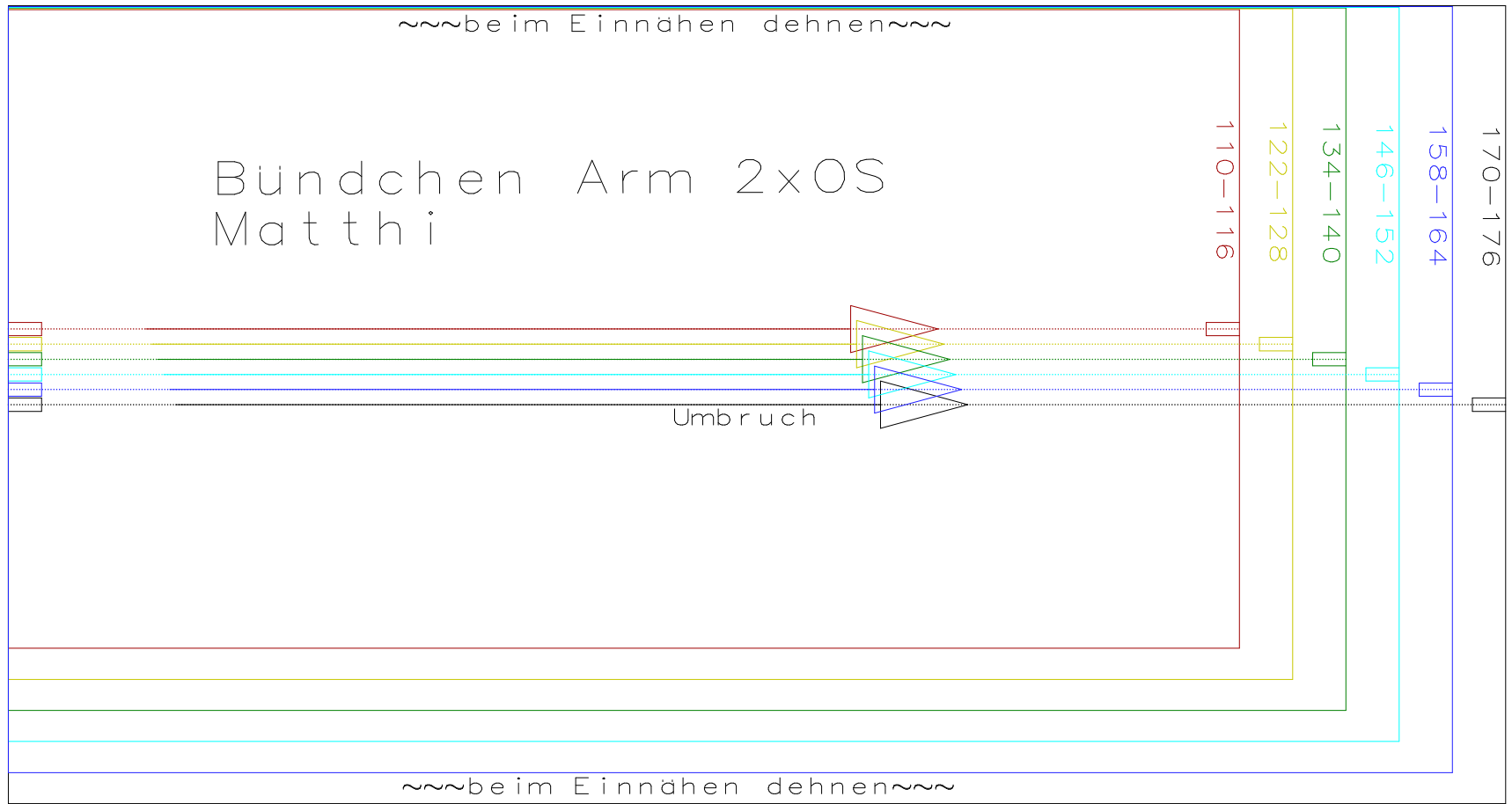



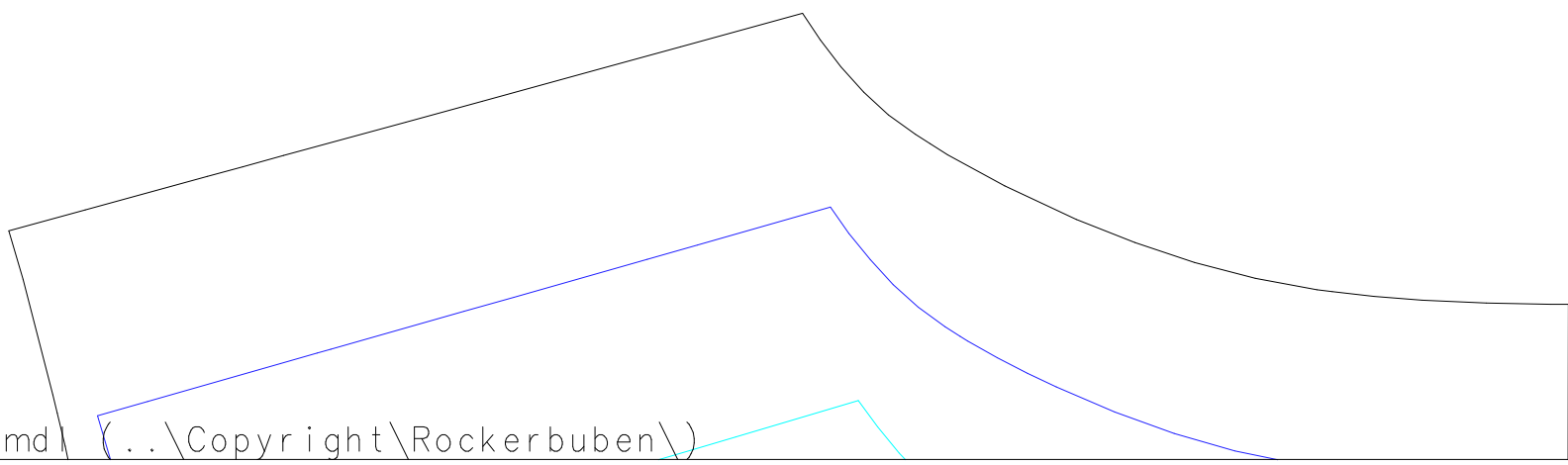
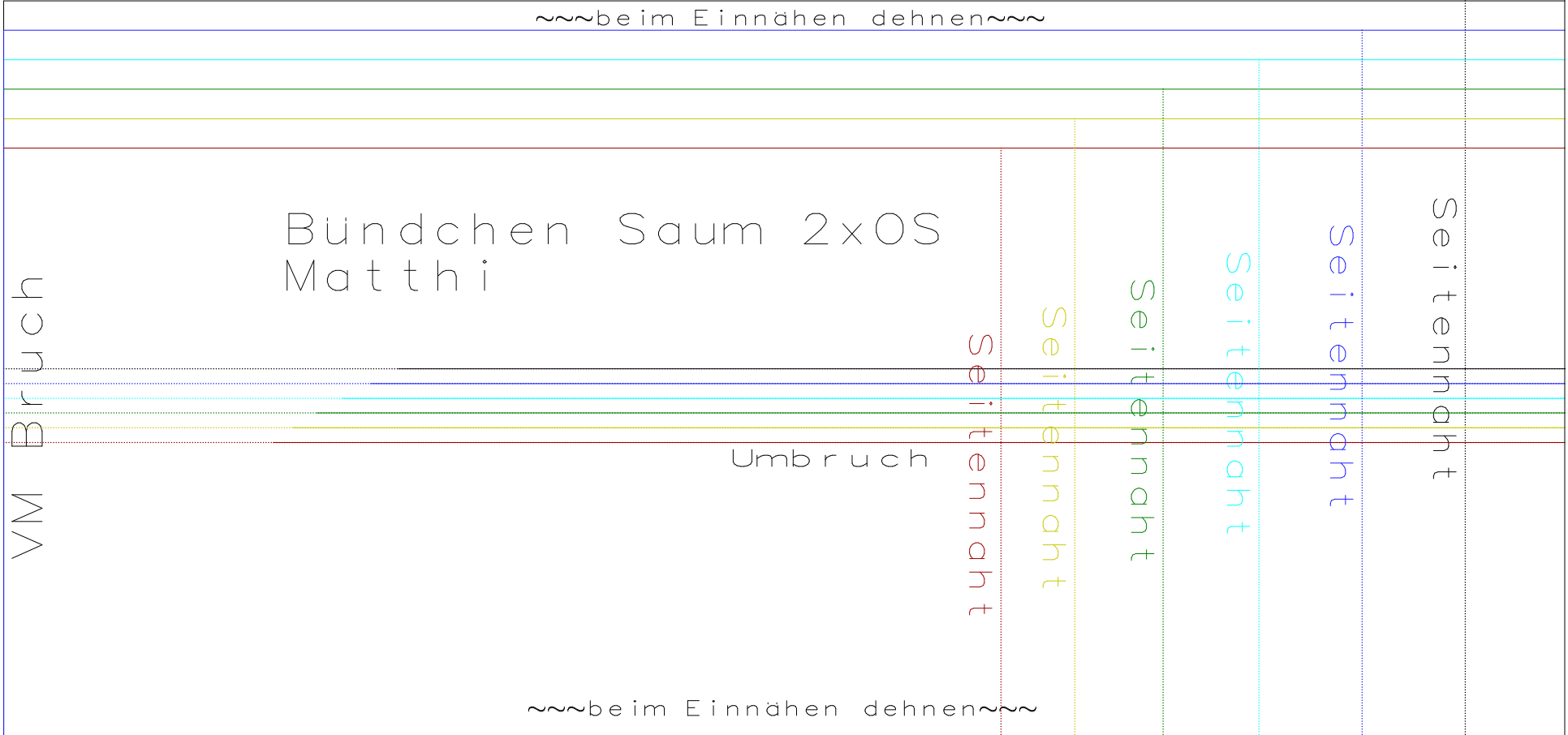

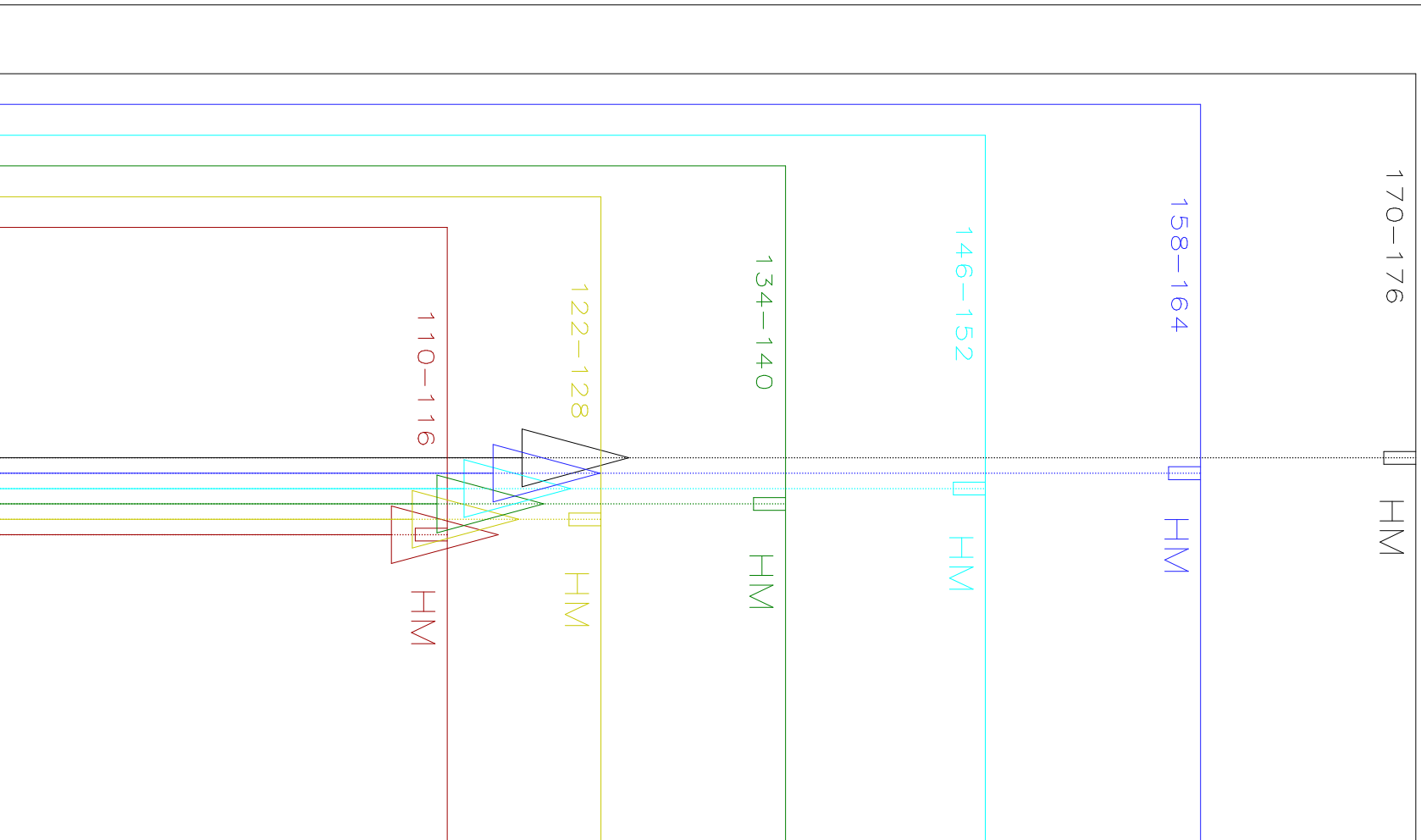
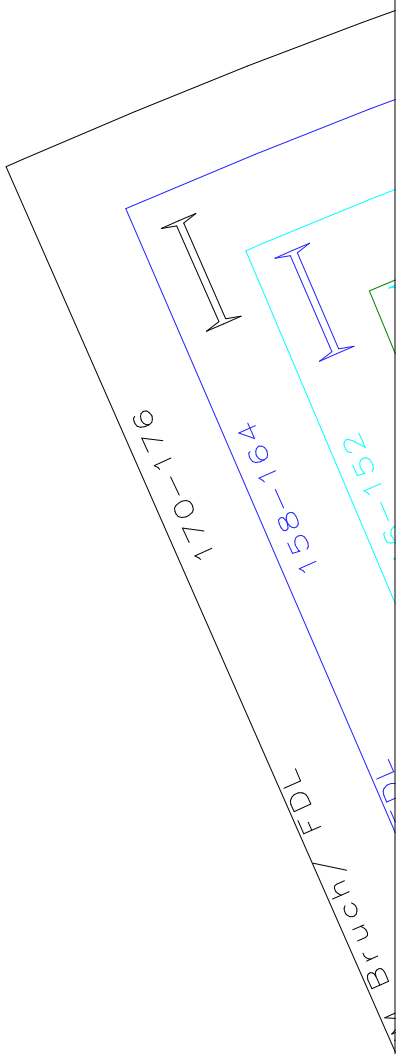

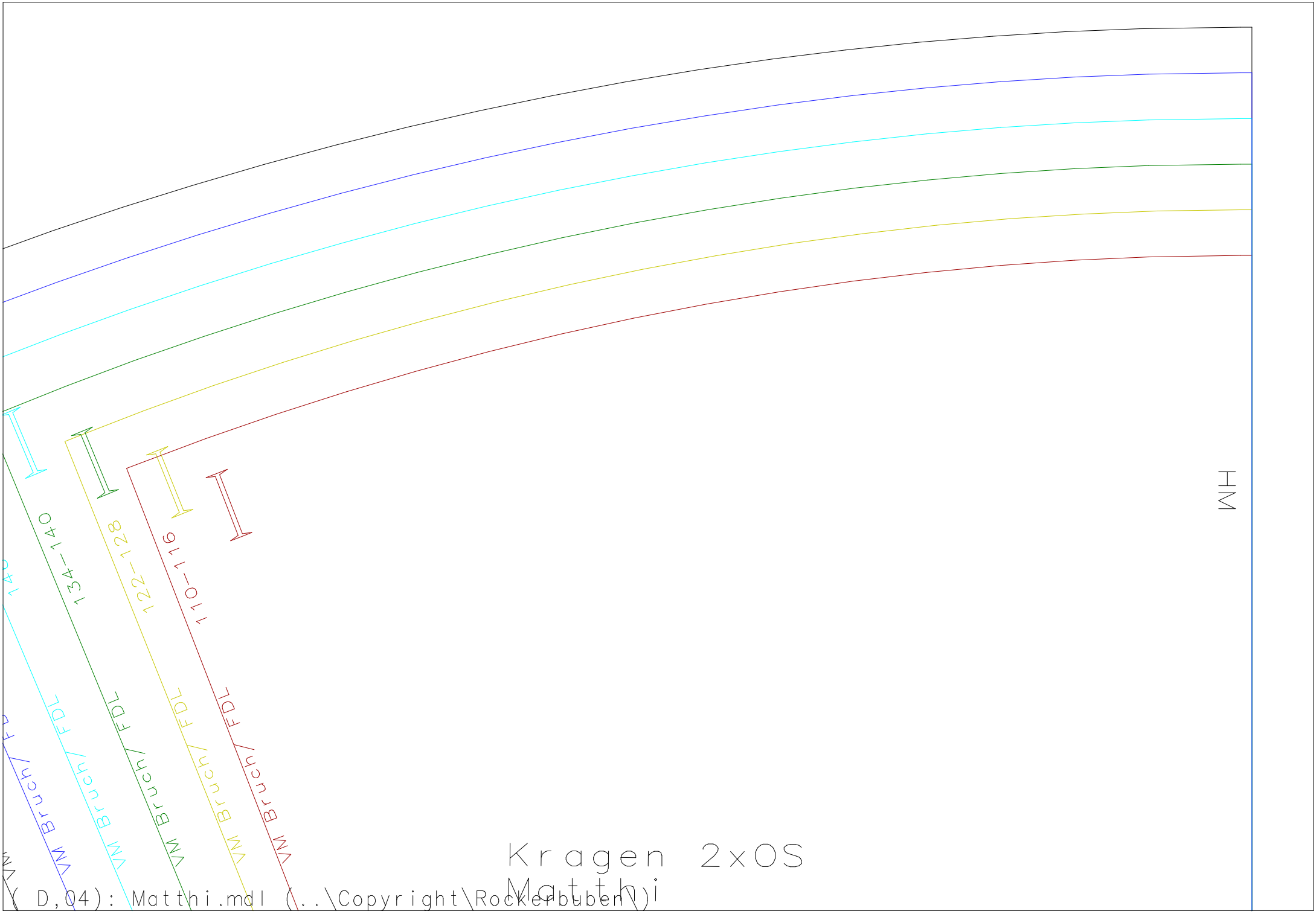

Kragen 2x0S

Matthi

